

Varenummer: 20956502
 Beskrivelse: E+G Justerfod
 GN 342.2-32-M10-50-SV

Mål

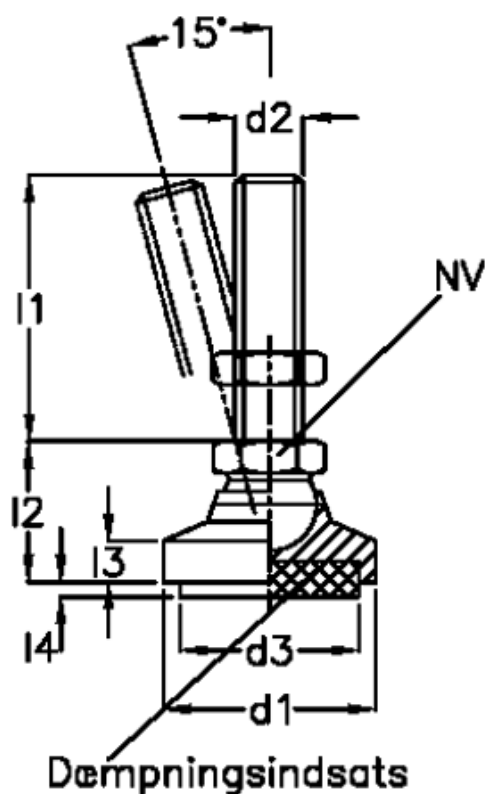

Area(m2) damping insert = 707	l4 compression 0,4 N/mm2	= 4.3
d1 = 32	l4 compression 0,6 N/mm2	= 3.4
d2 = M10	Load (N) by compression 0,4 N/mm2	= 280
d3 = 30	NV	= 16
l1 = 50	t	= 10.5
l2 = 29.0		
l3 = 11.0		
l4 compression 0 N/mm2 = 5.5		